

VOORAANZICHT - VUE FRONTALE  
VORDERANSICHT - FRONT VIEW

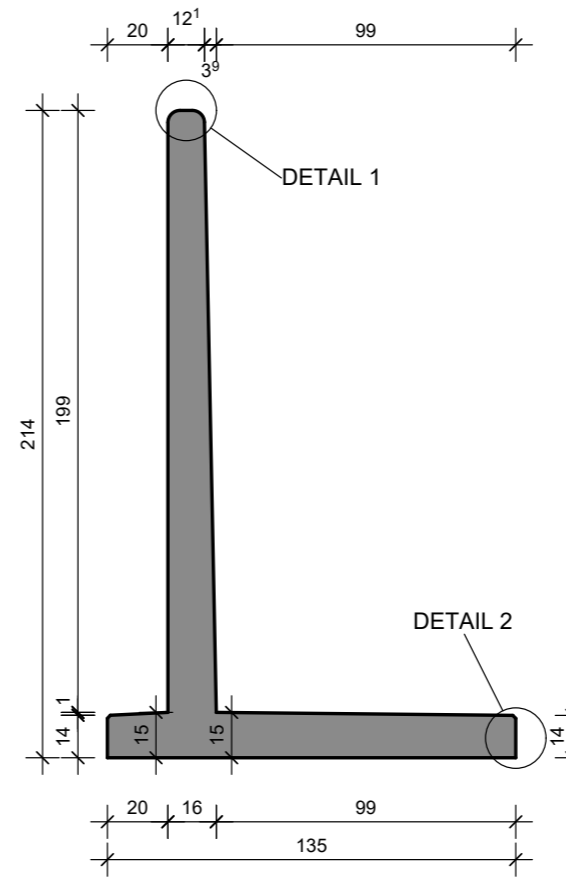

DOORSNEDE - COUPE TRANSVERSALE  
QUERSCHNITT - CROSS SECTION



3D

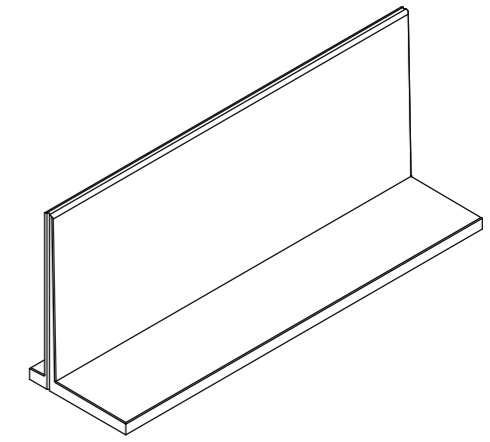

TECHNISCHE FICHE / FICHE TECHNIQUE  
TECHNISCHE DATEN / TECHNICAL DATA

element / élément / Element / element

CLAR 214x500

sterkteklasse / classe de résistance Festigkeitsklasse / strength class	C60/75	artikelnr. / numéro d'article Artikelnr. / item number	12080
sterkte bij levering / résistance lors de la livraison Festigkeit bei Lieferung / strength at delivery	/	versie / version Version / version	20200109
betondekking / enrobage de béton Betondeckung / concrete cover	30mm	productie / production Herstellung / production	Wielsbeke / Emmen
milieuklasse / classe d'exposition Expositionklasse / exposure class (EN 206)	XC4, XF3, XA3	volumen / volume Volumen / volume	2.36 m³
staalkwaliteit / qualité de l'acier Stahlqualität / steel quality	B500B	gewicht / poids Gewicht / weight	5900 kg
		ankers / ancrés Anker / anchors	RTA: / KKA: /

BOVENAANZICHT - VUE SUPERIEURE  
DRAUFSICHT - TOP VIEW

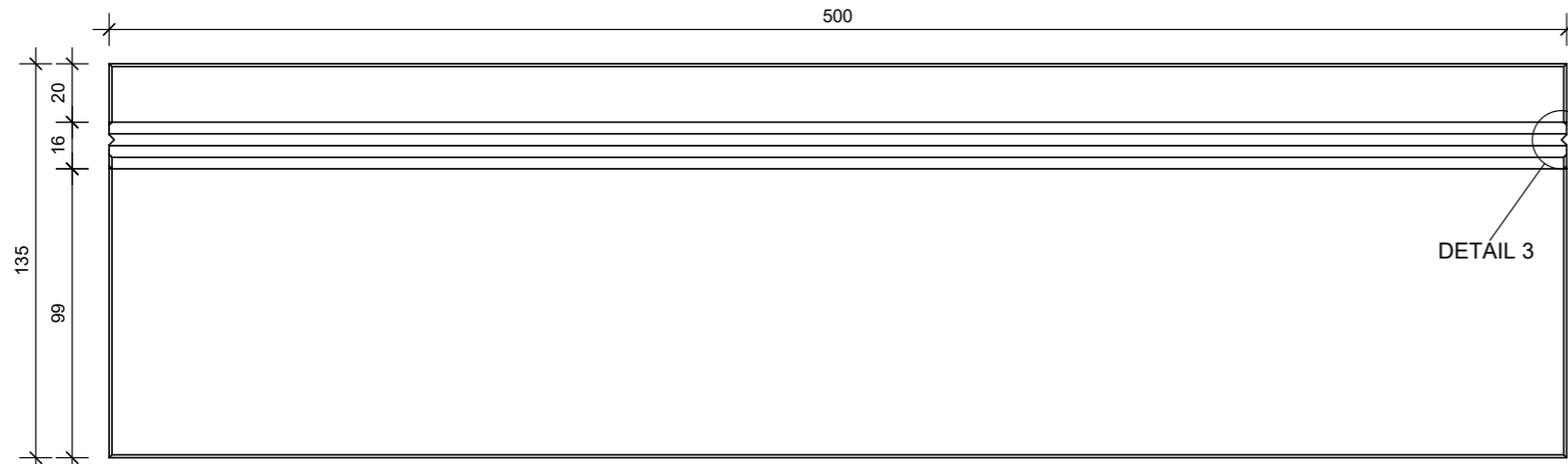

DETAIL 1

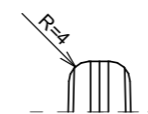

DETAIL 2

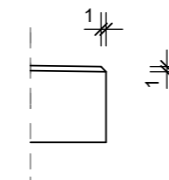

DETAIL 3

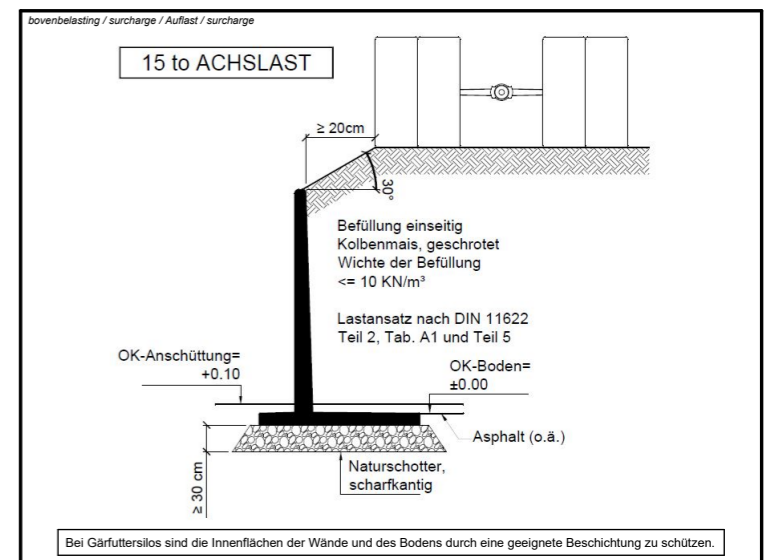
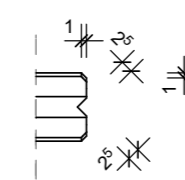

CBS BETON GmbH  
Bahnhofstrasse 2  
D-54608 Bleialf

Tel. +49 6555 900 19 80  
Fax +49 6555 900 19 819

info@cbs-beton.de  
www.cbs-beton.de