

Doorsnede (1/30)

Perspectief (1/40)

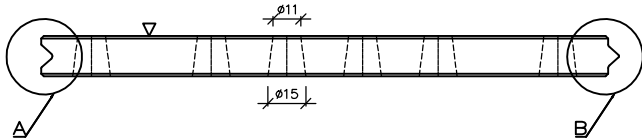

Detail A (1/5)

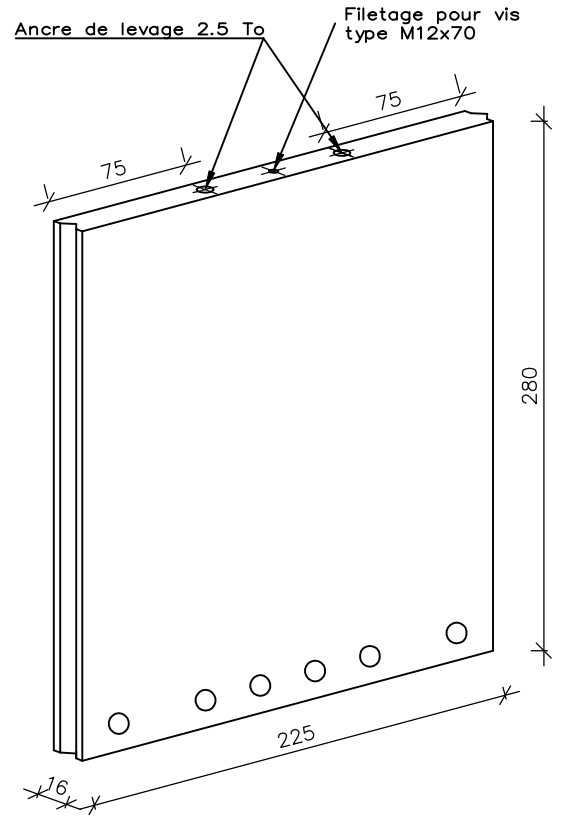
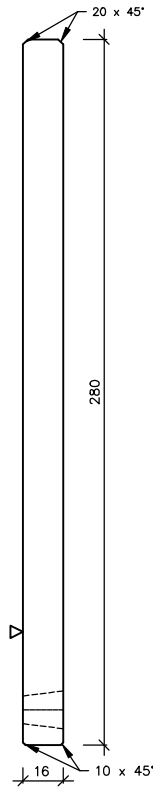
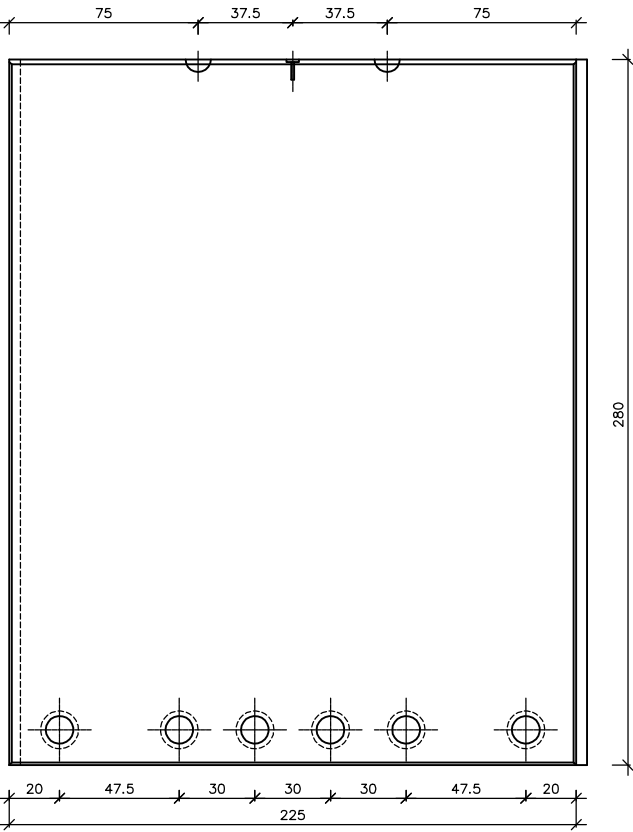
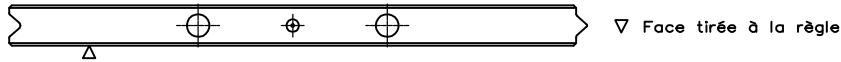
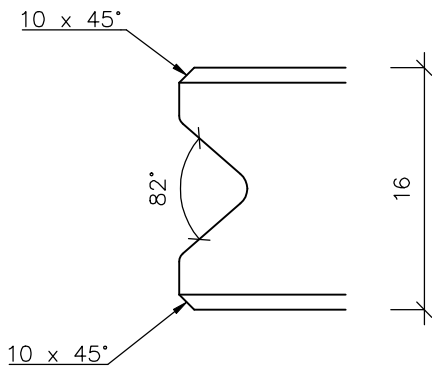

Detail B (1/5)

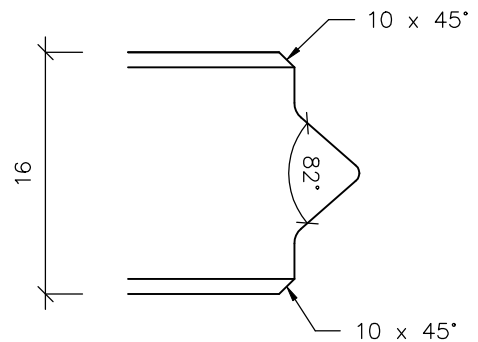

Betonsterkte:	C 60/75
Omgevingsklasse:	EA3, EE4, ES4
Betondekking:	30 mm
Staal kwaliteit:	FeB 500
Overlast:	1000 kg/m ²



CBS Beton bvba
 Hooimeersstraat 8 | B-8710 Wielsbeke
 T +32 56 61 75 37 | F +32 56 61 75 39
 info@cbs-beton.com | www.cbs-beton.com

TECHNISCHE FICHE

Art.: CSAN 280x225

Ankers: Geen

Gew.: 2390 kg

Klant:

Ref.:

Handtekening:

Akkoord:

Nr.: 11927